

Varenummer: 0107052
 Beskrivelse: Seeger låsering AK 35 DIN 983

Mål

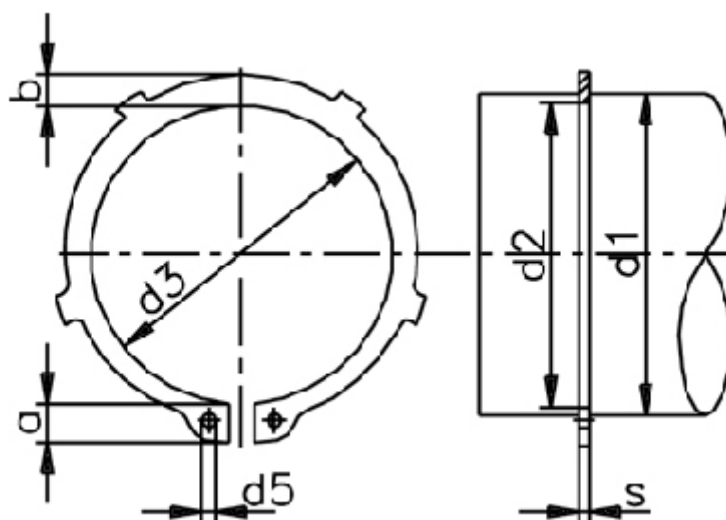

a max	= 5.2	d5 min	= 2.5	Nominal træk	= 3.0
AN mm ²	= 106.0	FN kN	= 17.80	s	= 1.50
Antal takker	= 6	FRg kN	= 5.5	t	= 1.00
b	= 3.8	FR kN	= 30.8	Tang	= ZGA-2
Betegnelse	= AK 35	g	= 2.0	tol	= -0.06
d1	= 35	K kN-mm	= 60.1	tol	= +0,25-0,50
d2	= 33.0	m min	= 1.60	tol	= -0.25
d3	= 32.2	n abl x 1000	= 15	vægt kg/1000	= 4.38